





- 1 mount cap
- 2 main body
- 3 clamp
- 4 elastic gasket
- 5 allen screw M8x60mm
- 6 metal plugs M10-12

 oval cap in natural anodization, stainless steel imitation, RAL 5m and 6m rods

 rectangular cap in natural anodization, stainless steel in 5m, 6m and 6,5m rods, RAL colours in 5m and 6m rods

 oval end taps with and without notch in natural anodization, stainless steel 304 and RAL colours

 rectangular end taps with and without notch in natural anodization, stainless steel 304 and RAL colours

mount	plugs
L150 (150mm)	2
L200 (200mm)	2
L300 (300mm)	3
L400 (400mm)	3
L150/250 (150/250mm)	2
L200/300 (200/300mm)	3
L300/400 (300/400mm)	3

profile weight ~7.2kg/m
aluminum alloy EN AW 6060 T66, AlMgSi 0.5 F22

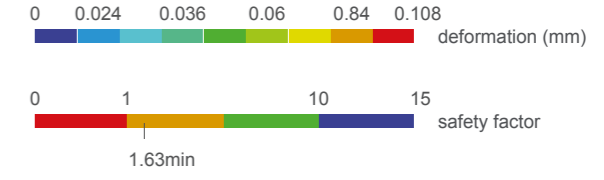
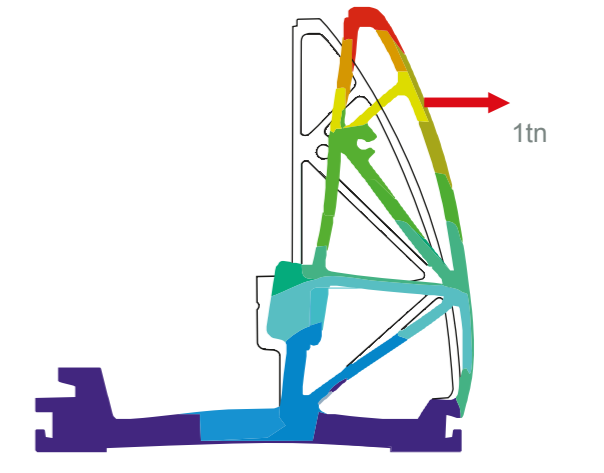

max allowable torque of allen screw tightening (cat 8.8)

M6	7.2Nm
M8	18Nm
M10	36Nm
M12	62Nm

Strain load on 50cm mount with 1ton (,000Nt) vertically on glassboard holding surface.

recommended support:

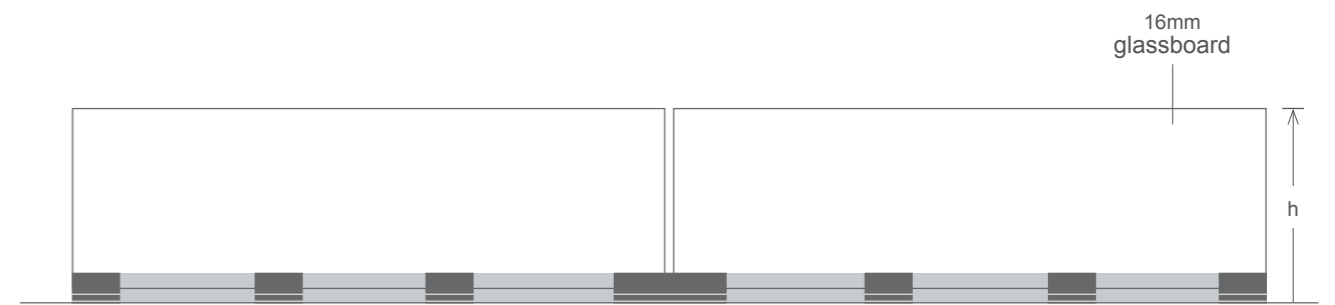

h (cm)	100	90	80	70	60	50	40
d (cm)	25-30	30-35	35-40	40-45	45-55	55-70	70-90